



สวทช.
NSTDA

ขับเคลื่อนวิทยาศาสตร์และเทคโนโลยี
ด้วย **AI** เพื่อประเทศไทยที่ยั่งยืน
*All-driven Science and Technology
for Sustainable Thailand*



NAC2025
20th NSTDA Annual Conference
การประชุมวิชาการประจำปี สวทช. ครั้งที่ ๒๐

26-28
มีนาคม 2568

อุทยานวิทยาศาสตร์ประเทศไทย



From Theory to Practice: Leveraging ICTES at Botnoi Group

Discover how ICITES principles transformed theoretical knowledge into the practical innovations driving Botnoi Group's innovation and success

Botnoi Group

We streamline communications through AI

www.botnoigroup.com

Since 2017

Introduction



Form of Expertise in AI

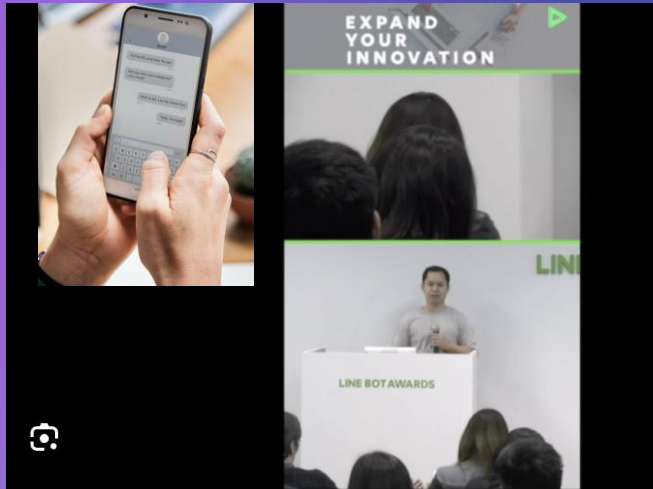

BOTNOI got LINE chatbot "Conversation Engine Category" award - YouTube

Chatbots
(LINE BOT Award 2017)



Live call : Botnoi x AWS AI Voice Agent Open house

Uploaded: May 29, 2024 · 184 Views · 1 Likes

Voicebots
(Go to market with Amazon Connect)

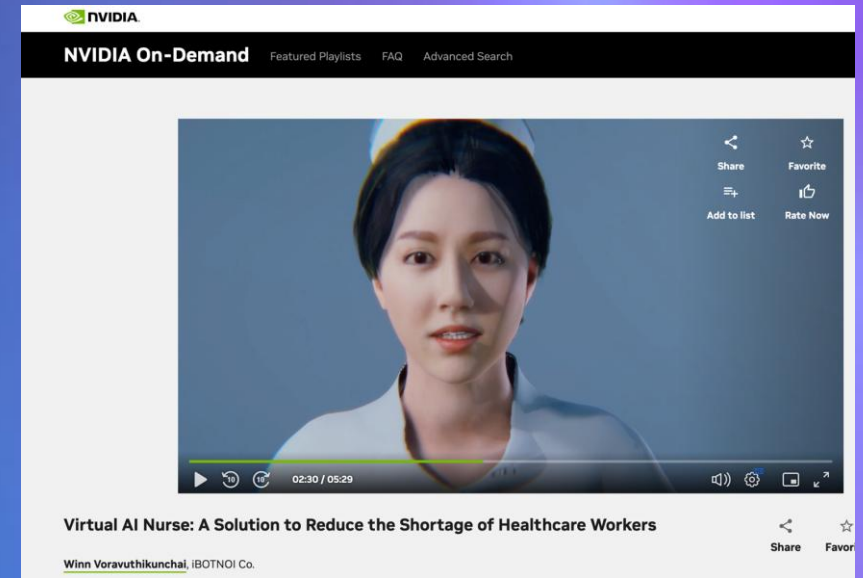

Digital human
(resented at NVIDIA GTC)

AI Technology Solutions



Processing

Highlight

- NVIDIA helps in AI expert optimization through Inception program



Speech to text

Highlight

- Supporting AWS regional team in ASEAN speech recognition



Large Language Model

Highlight

- Doit invited to present LLM Voicebot @ AWS reInvent 2024

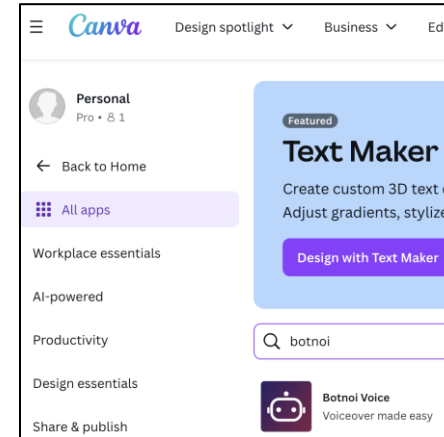

Text-to-Speech

Highlight

- In Canva app
- 100k Monthly Active Users



Computer Vision

Highlight

- AI News announcers for many news channels

Evolution of Technology Solution



NAC2025
20th NSTDA Annual Conference
กรมส่งเสริมการค้าระหว่างประเทศ กระทรวงพาณิชย์

26-28
มีนาคม 2568

กรุงเทพมหานคร



NLP



BOTNOI

Refined NLP
Techniques

Speech-To-
Text



STT

Improved
Speech
Recognition

Text-To-
Speech



VOICE

Enhanced
Text-to-speech
Capabilities

LLM



ChatGPT



Bard

Generative AI:
Making
Solutions
Possible Today

Data Analytic



Data Analytic
Better for
Customer
Understanding

Our Solutions



Debt collection



Confirmation



Reservation



Recommendation



Status Enquiry



Customer
Care

Our Customers' Engagement



NAC2025
 20th NSTDA Annual Conference
 การประชุมวิชาการประจำปี สวทช. ครั้งที่ 20

26-28
มีนาคม 2568

กรุงเทพมหานคร



VOICE STUDIO VOICE OVER USAGE API PRICE SALE VOICE BOT EN LOG IN

WELCOME TO BOTNOI VOICE

CONVERT TEXT TO SPEECH

Easily convert text into realistic speech. More than 10+ languages to choose, helping your work smoothly, whether it be voice over, dubbing, teaching media, reading news, presentation slides, podcasts, reading novels, finishing work easily, can be done anywhere.

English Thai Chinese Japanese Burmese Lao Vietnamese Indonesian Cambodia Filipino

Please select the language first.

Try typing the sentence here.

Free credit: 3 Downloads left / Day
 Try full version for more

Generate

LET'S TRY FREE

Trusted by 15 Million users across the world

Average number of users: **120,000 Users/Month**

Total Generated: **15M+ Downloads**

CHATBOT ALL CHATBOT PRICE DOCUMENT REPORT PROBLEM

botnoi2021

Create Dialogue

Object Name: dl_personalbot

Match this condition

Entities: umbar

Select Entry or Enter Phrase

Save Entities

Add more condition

Sub Tag

Apply Tag

Add more command

If the response doesn't match any

Enter message

Main Tag

Apply Tag

RegEx

Match this condition

RegEx

Character

Add more condition

Sub Tag

Apply Tag

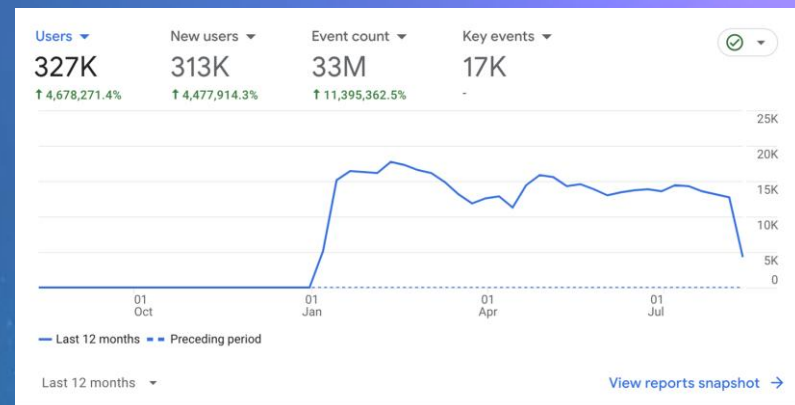
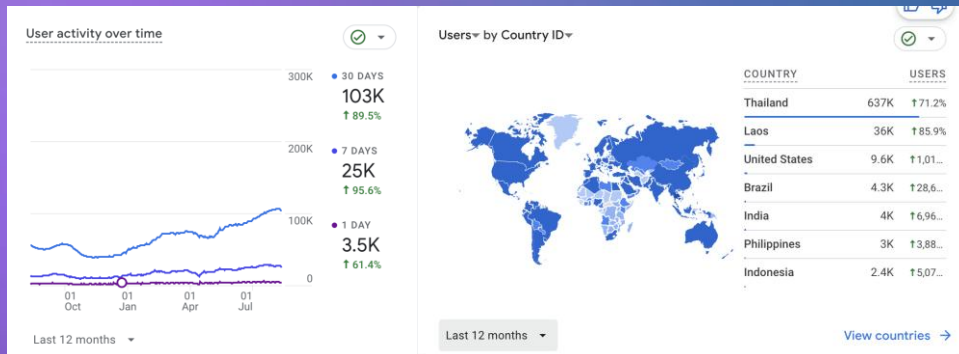

Text to speech <https://voice.botnoi.ai>

Chatbot platform <https://botnoi.ai>

Overview Solution

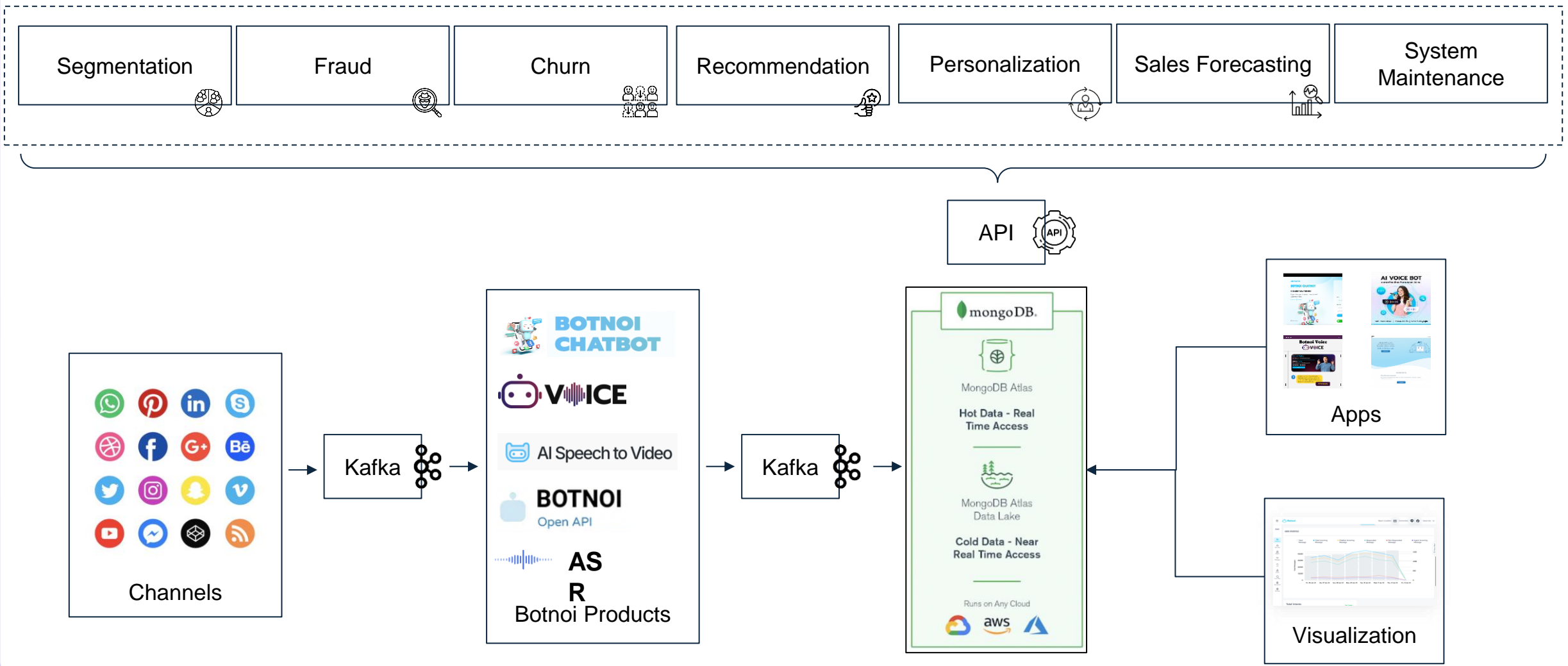

Overview Solution

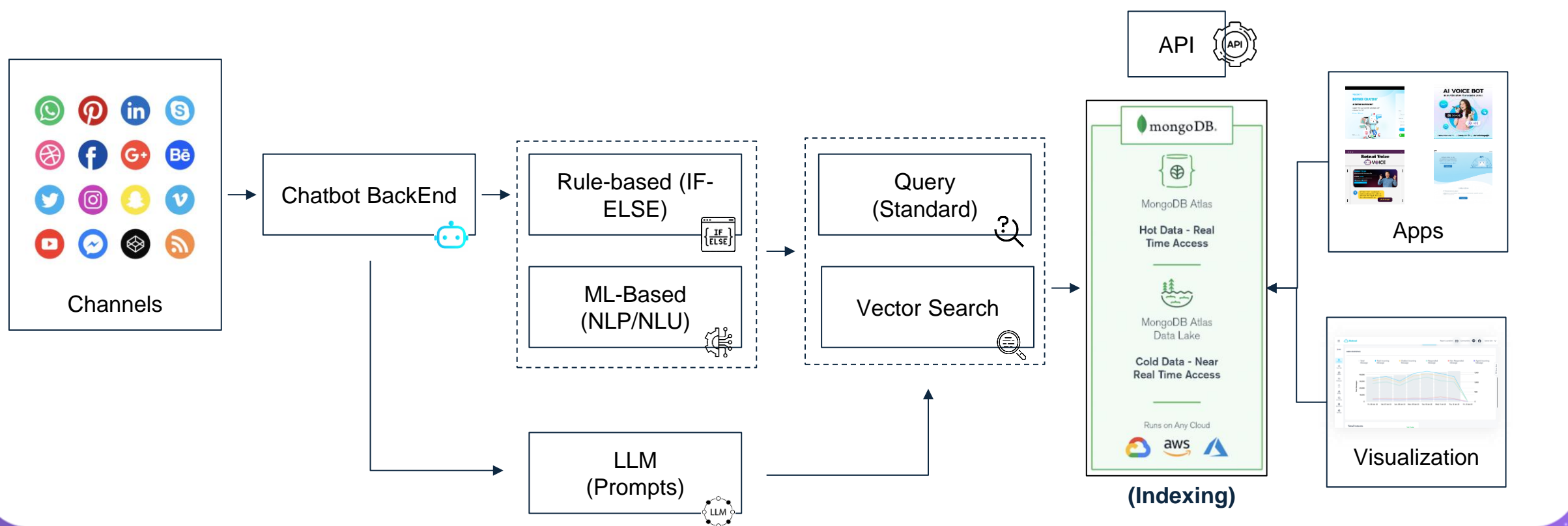

Overview Solution

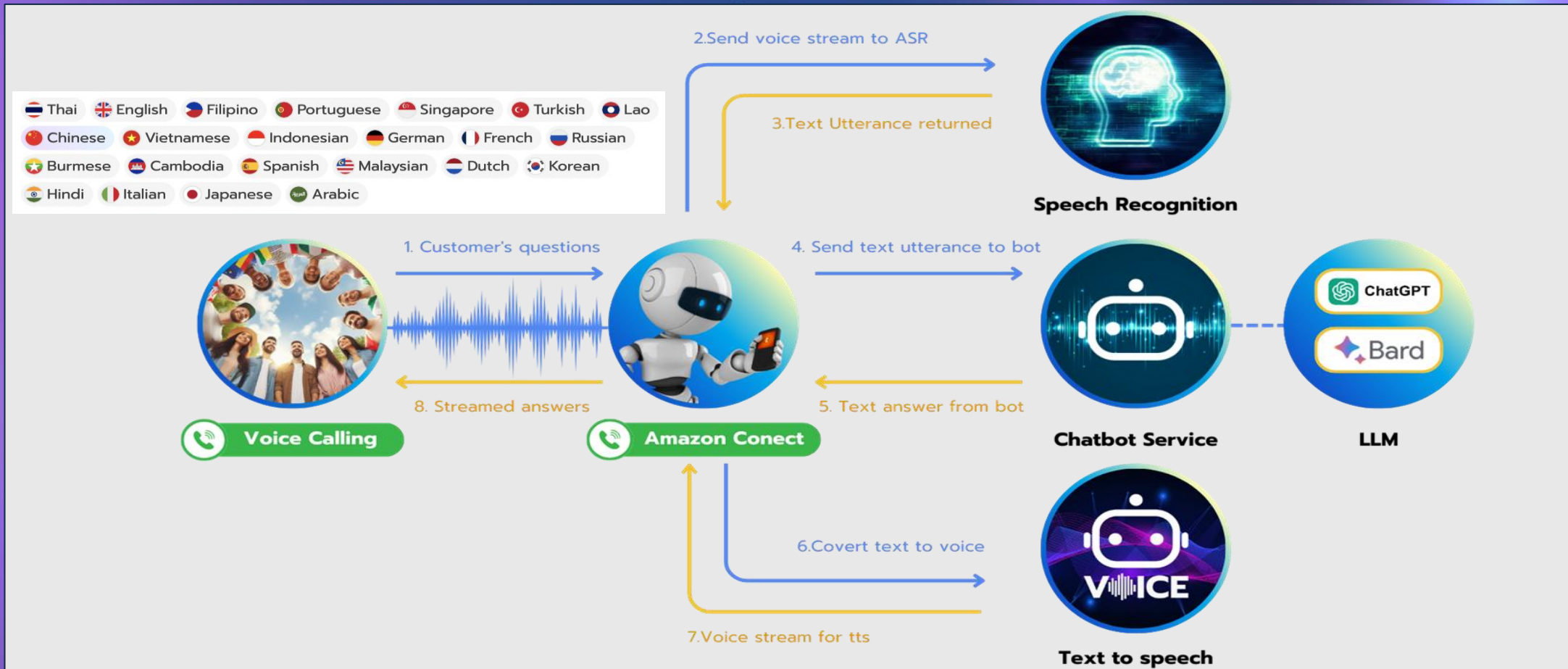

AI Nurse (Demo)



NAC2025
20th NSTDA Annual Conference
การประชุมวิชาการประจำปี สวทช. ครั้งที่ ๒๐

26-28
มีนาคม 2568

[ดูรายละเอียดกิจกรรมคลิก](#)



A video frame showing a virtual AI nurse. On the left, the text "Virtual AI Nurse" is displayed in blue and white. Below it is a blue robot head icon and the text "iBOTNOI" in white, with "Leading AI firm in South East Asia" underneath. On the right, a woman with dark hair, wearing a white nurse's uniform, is shown from the chest up. At the bottom of the frame, the text "NVIDIA INCEPTION | GTC 2021" and the NVIDIA logo are visible. A small number "1" is in the bottom right corner of the video frame.



**Chief Executive Officer
Dr. Winn Voravuthikunchai**

- Advisor to the AI Study Commission Thailand 2024
- Founder & CEO BOTNOI Group 2017
- Chief Data Scientist, Telenor Digital 2017
- Group Data Scientist, Telenor Group 2015
- Senior Data Scientist, AirAsia Group 2014
- PhD Computer Vision, University of Caen, France, 2013
- MSc Computer Vision, Ulm university, Ulm 2009



BOTNOI AI & Tech talent

- 12 Data scientists
- 5 Dev/ML Ops
- 20 Software developers

- 30 AI engineers (Speech/NLP/LLM/CV)
- 12 Conversational UX



**Chief Technology Officer
Dr. Piyoros Tungthamthiti**

- Co-Founder & CTO BOTNOI Group 2017
- Senior Data Scientist, Telenor Digital 2017
- Group Data Scientist, Telenor Group 2016
- Senior Research Scientist - NLP & ML, Thoth Social
- PhD NLP, Japan Advanced Institute of Science and Technology (JAIST)
- M.Eng, TAIST-Tokyo Tech, ICTES, SIIT, Thammasat University



Train AI & Tech talent

- 10 MOUs with universities
- 500+ Students internship given
- 20k Community members
- 3k Teachers in our AI community

Thank You



Company Website: <https://botnoigroup.com/>

Chatbot: <https://botnoi.ai/>

Text-To-Speech: <https://voice.botnoi.ai/>

Digital Human: <https://botnoigroup.com/ai/digitalhuman>

Speech-To-Text: <https://botnoigroup.com/ai/speechtotext>

Computer Vision: <https://botnoigroup.com/ai/computervision>